

Все шкивы под клиновые ремни изготовлены в соответствии с нормами ISO 4183 и DIN 2211-3.

В качестве материала для изготовления данных шкивов используется литейный чугун EN-GJL-200 UNI EN 1561. После механической обработки все шкивы подвергаются фосфатированию.

Для всех шкивов выполнена статическая балансировка и они пригодны для окружных скоростей до 35 м/с.

В настоящем каталоге предлагаются шкивы для клиновых ремней SPZ, SPA, SPB, SPC под втулку тапербуш, а также с черновым отверстием под расточку.

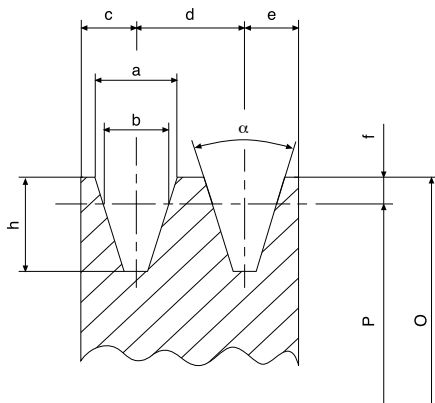

Расчет окружной скорости V_p в м/с:

$$V_p = \frac{\pi \cdot P \cdot n}{60 \cdot 1000} \approx \frac{P \cdot n}{19100}, \quad V_p \leq 35 \text{ м/с}$$

где:

P – расчетный диаметр, мм

n – скорость вращения, об./мин

Размеры канавок

Профиль канавки	a, мм	b, мм	c, мм	d, мм	e, мм	f, мм	h, мм	$\alpha = 34^\circ$	$\alpha = 38^\circ$
SPZ	9,7	8,5	8	12	8	2	11	$P \leq 80$	$P > 80$
SPA	12,7	11	10	15	10	2,8	13,8	$P \leq 118$	$P > 118$
SPB	16,3	14	12,5	19	12,5	3,5	17,5	$P \leq 190$	$P > 190$
SPC	22	19	17	25,5	17	4,8	23,8	$P \leq 315$	$P > 315$

Размеры ремня

Профиль	m, мм	s, мм	n, мм
SPZ	9,7	8	8,5
SPA	12,7	10	11
SPB	16,3	13	14
SPC	22	18	19

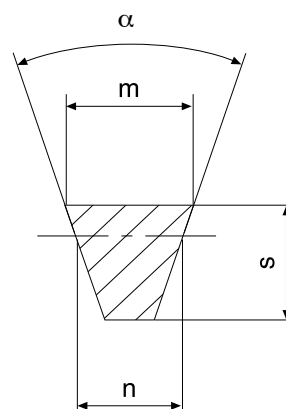

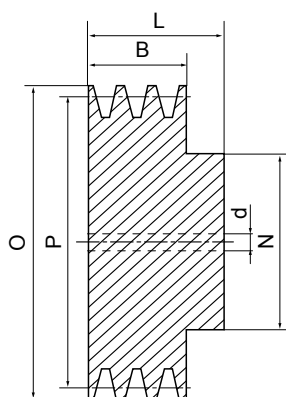

исп. 1

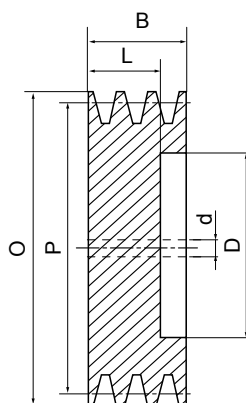

исп. 2

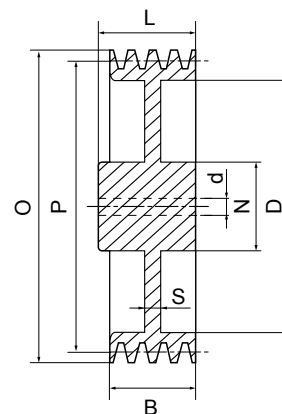

исп. 3

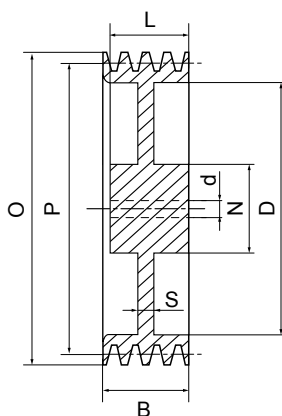

исп. 4

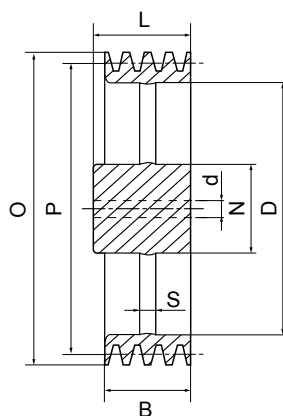

исп. 5

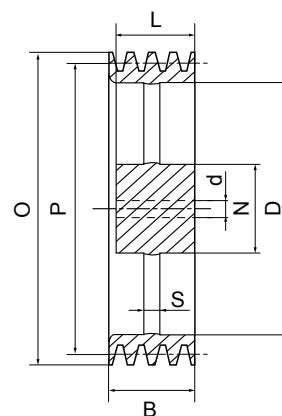

исп. 6

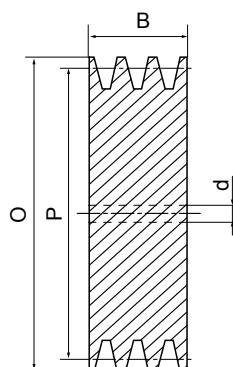

исп. 7

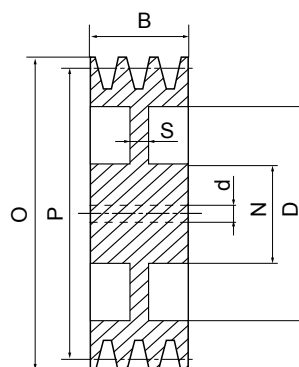

исп. 8



SPA

КОД	Тип	P, мм	O, мм	Количество каналов	N, мм	L, мм	D, мм	S, мм	B, мм	Исп.	d, мм	
AM00401	SPA40	40	45,5	1	40	35			20	1	10	
AM00501	SPA50	50	55,5	1	40	35			20	1	10	
AM00502				2	40	45			35	1	10	
AM00561	SPA56	56	61,5	1	40	35			20	1	10	
AM00562				2	40	45			35	1	10	
AM00563				3					50	7	10	
AM00603	SPA60	60	65,5	1	40	35			20	1	10	
AM00631	SPA63	63	68,5	1	40	35			20	1	10	
AM00632				2	40	45			35	1	10	
AM00633				3					50	7	10	
AM00711	SPA71	71	76,5	1	40	40			20	1	10	
AM00712				2	50	45			35	1	10	
AM00713				3					50	7	10	
AM00751	SPA75	75	80,5	1	40	40			20	1	10	
AM00752				2	50	45			35	1	10	
AM00753				3					50	7	10	
AM00754				4					65	7	10	
AM00755				5					80	7	10	
AM00801	SPA80	80	85,5	1	45	40			20	1	10	
AM00802				2	50	45			35	1	10	
AM00803				3					50	7	15	
AM00804				4					65	7	15	
AM00805				5					80	7	15	
AM00851	SPA85	85	90,5	1	45	40			20	1	10	
AM00852				2	50	45			35	1	10	
AM00853				3					50	7	15	
AM00854				4					65	7	15	
AM00855				5					80	7	15	
AM00901	SPA90	90	95,5	1	45	40			20	1	10	
AM00902				2	60	45			35	1	15	
AM00903				3					50	7	15	
AM00904				4					65	7	15	
AM00905				5					80	7	15	
AM00951	SPA95	95	100,5	1	45	40			20	1	10	
AM00952				2	60	45			35	1	15	
AM00953				3					50	7	15	
AM00954				4					65	7	15	
AM00955				5					80	7	15	
AM01001	SPA100	100	105,5	1	48	40			20	1	10	
AM01002				2	60	45			35	1	15	
AM01003				3					50	7	15	
AM01004				4				52	67	65	2	15
AM01005				5				52	67	80	2	15
AM01061	SPA106	106	111,5	1	48	40			20	1	10	
AM01062				2	60	45			35	1	15	
AM01063				3					50	7	15	
AM01065				5				52	67	80	2	15
AM01121	SPA112	112	117,5	1	48	40			20	1	10	
AM01122				2	60	45			35	1	15	
AM01123				3					50	7	15	
AM01124				4				52	79	65	2	15
AM01125				5				52	79	80	2	15
AM01181	SPA118	118	123,5	1	60	40			20	1	15	
AM01182				2	60	45			35	1	15	
AM01183				3					50	7	15	
AM01184				4				52	87	65	2	15
AM01185				5				52	87	80	2	15



SPA (продолжение)

КОД	Тип	P, мм	O, мм	Количество канавок	N, мм	L, мм	D, мм	S, мм	B, мм	Исп.	d, мм
AM01251	SPA125	125	130,5	1	60	40			20	1	15
AM01252				2	60	45			35	1	15
AM01253				3					50	7	15
AM01254				4			52	97	65	2	15
AM01321	SPA132	132	137,5	1	60	40			20	1	15
AM01322				2	60	45			35	1	15
AM01323				3					50	7	15
AM01324				4			52	97	65	2	15
AM01325				5			52	97	80	2	15
AM01401	SPA140	140	145,5	1	60	40	107	10	20	3	15
AM01402				2	60	45	107	10	35	3	15
AM01403				3	65	52	107	18	50	3	20
AM01404				4			52	107	65	2	20
AM01405				5			52	107	80	2	20
AM01501	SPA150	150	155,5	1	60	40	117	10	20	3	15
AM01502				2	60	45	117	10	35	3	15
AM01503				3	65	52	117	18	50	3	20
AM01504				4			52	117	65	2	20
AM01505				5			52	117	80	2	20
AM01601	SPA160	160	165,5	1	60	40	127	10	20	3	15
AM01602				2	60	45	127	10	35	3	15
AM01603				3	70	52	127	18	50	3	20
AM01604				4	70	52	127	22	65	4	20
AM01605				5	80	52	127	22	80	4	20
AM01701	SPA170	170	175,5	1	60	40	137	10	20	3	15
AM01702				2	60	45	137	10	35	3	15
AM01703				3	70	52	137	18	50	3	20
AM01704				4	80	52	137	18	65	4	20
AM01705				5	80	52	137	18	80	4	20
AM01801	SPA180	180	185,5	1	65	40	147	10	20	3	20
AM01802				2	70	50	147	12	35	3	20
AM01803				3	70	52	147	12	50	3	20
AM01804				4	80	60	147	22	65	4	20
AM01805				5	80	65	147	22	80	4	20
AM01902	SPA190	190	195,5	2	70	50	157	12	35	3	20
AM01903				3	70	52	157	12	50	3	20
AM01904				4	80	60	157	18	65	4	20
AM02001	SPA200	200	205,5	1	65	45	167	10	20	3	20
AM02002				2	70	50	167	12	35	3	20
AM02003				3	70	52	167	12	50	3	20
AM02004				4	80	60	167	18	65	4	20
AM02005				5	80	65	167	20	80	4	20
AM02121	SPA212	212	217,5	1	65	40		10	20	3	20
AM02122				2	70	45		12	35	3	20
AM02241	SPA224	224	229,5	1	65	45	192	10	20	3	20
AM02242				2	70	50	192	12	35	3	20
AM02243				3	80	52	192	12	50	3	20
AM02244				4	90	60	192	18	65	4	20
AM02245				5	90	65	192	20	80	4	20
AM02361	SPA236	236	241,5	1		50		12	20	3	20
AM02362				2		50		12	35	3	20
AM02501	SPA250	250	255,5	1	75	50	217	12	20	3	20
AM02502				2	75	50	217	12	35	3	20
AM02503				3	80	60	217	12	50	3	20
AM02504				4	90	65	217	18	65	3	20
AM02505				5	90	65	217	20	80	4	20
AM02801	SPA280	280	285,5	1	75	50	247	14	20	5	20
AM02802				2	80	50	247	14	35	5	20
AM02803				3	80	60	247	14	50	5	20
AM02804				4	90	65	247	16	65	5	20
AM02805				5	100	65	247	18	80	6	25



SPA (продолжение)

КОД	Тип	P, мм	O, мм	Количество канавок	N, мм	L, мм	D, мм	S, мм	B, мм	Исп.	d, мм
AM03001	SPA300	300	305,5	1	75	50	267	14	20	5	20
AM03002				2	80	50	267	14	35	5	20
AM03003				3	80	60	267	14	50	5	20
AM03004				4	90	65	267	16	65	5	20
AM03005				5	100	65	267	18	80	6	25
AM03151	SPA315	315	320,5	1	75	60	282	14	20	5	20
AM03152				2	80	50	282	14	35	5	20
AM03153				3	90	60	282	14	50	5	20
AM03154				4	90	65	282	16	65	5	20
AM03155				5	100	65	282	18	80	6	25
AM03551	SPA355	355	360,5	1	75	50	322	14	20	5	20
AM03552				2	80	50	322	14	35	5	20
AM03553				3	90	60	322	14	50	5	20
AM03554				4	90	65	322	16	65	5	25
AM03555				5	100	65	322	18	80	6	25
AM04001	SPA400	400	405,5	1	90	50	367	14	20	5	20
AM04002				2	90	50	367	14	35	5	20
AM04003				3	100	60	367	16	50	5	25
AM04004				4	100	65	367	20	65	5	25
AM04005				5	100	65	367	22	80	6	25
AM04501	SPA450	450	455,5	1	90	50	417	14	20	5	20
AM04502				2	100	50	417	14	35	5	25
AM04503				3	100	60	417	16	50	5	25
AM04504				4	105	65	417	20	65	6	25
AM04505				5	105	65	417	22	80	6	25
AM05001	SPA500	500	505,5	1	90	50	467	14	20	5	20
AM05002				2	100	50	467	16	35	5	25
AM05003				3	105	60	467	20	50	5	25
AM05004				4	105	65	467	20	65	6	25
AM05005				5	110	65	467	22	80	6	25
AM05601	SPA560	560	565,5	1	100	50	527	15	20	5	25
AM05602				2	100	50	527	18	35	5	25
AM05603				3	120	65	527	20	50	5	25
AM05604				4	120	65	527	22	65	5	25
AM05605				5	120	80	527	24	80	5	25
AM05606				6	120	80	527	26	95	6	25
AM06301	SPA630	630	635,5	1	100	50	597	16	20	5	25
AM06302				2	110	50	597	18	35	5	25
AM06303				3	120	65	597	20	50	5	25
AM06304				4	120	65	597	22	65	5	25
AM06305				5	120	80	597	24	80	5	25
AM06306				6	120	80	597	26	95	6	25

